

# Plan, Sectional & Elevation Components

The Plan, Sectional & Elevation Components Library includes over 300 commonly used drag and drop parts for use in the floor plans, sectional views, foundation and elevation layers of your drawings. These are designed for use in layers while drawing a complete home or re-modelling plan. NOTE: These are for use with MacDraft 6.

## Dragging & Dropping using the MacDraft Library palette:

When you want to use a symbol or graphic stored in a library in a MacDraft document, you can retrieve items for use by the following:

### To drag and drop an item from the library:

1. Click the required item in the library to select it.
2. Holding down the mouse button, drag the item over the MacDraft document window.
3. Release the mouse button.

A copy of the item will be placed in the MacDraft document.

### To drag and drop an item from the library (UNSCALED):

1. Click the required item in the library to select it.
2. Holding down the mouse button, drag the item over the MacDraft document window.
3. Press the Shift key while dragging the item.
4. Release the mouse button.

An unscaled copy of the item will be placed in the MacDraft document.

### To drag and drop an item into the library palette:

1. Select the Library you wish to copy the item to in the Library palette.
2. Select the object or group in the MacDraft document that you want to put into the library.
3. Hold down the Command key.
4. Whilst holding the Command key down, drag the selection to the Library palette window.

----- \*\* MICROSPOT LIBRARIES LICENSE AGREEMENT \*\* -----

These products are licensed to the purchaser under the following conditions, but copyright remains the property of Microspot Ltd. The licensee may use the files to produce signs or other artwork which may be sold but licensee may not give or sell the files to any third party. The Licensee may make a copy for their own back up purposes. Although these files have been designed in the styles specified by certain governing bodies, Microspot does not accept responsibility for any non compliance with any recognized standard and the licensee must be responsible for their use of the symbols. © Copyright Microspot Ltd 2012. All rights reserved.

# THE LIBRARY CONTAINS THE FOLLOWING CATEGORIES

These are a preview of some of the items in the categories

## Elevations:

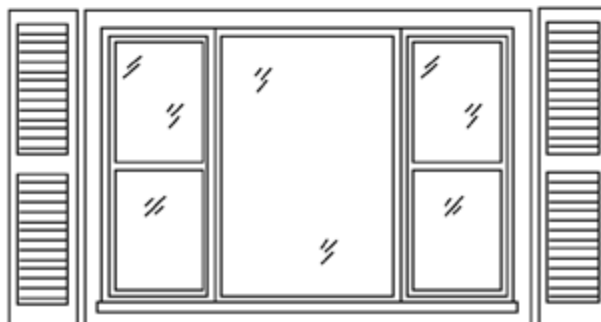
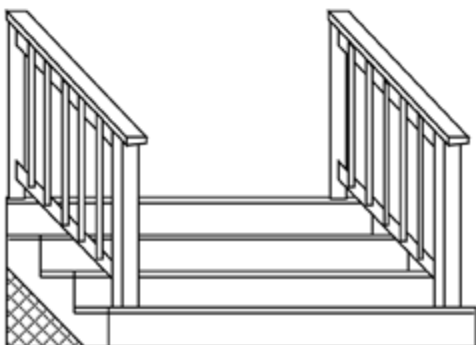
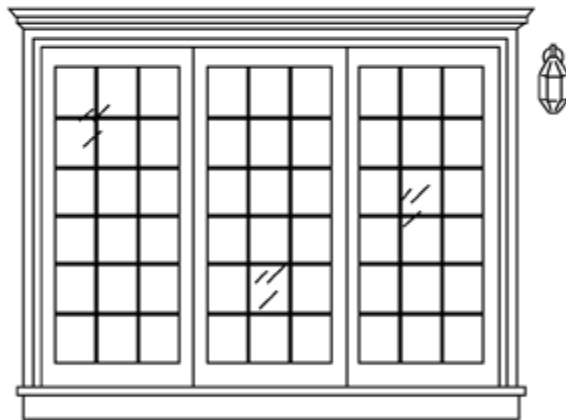
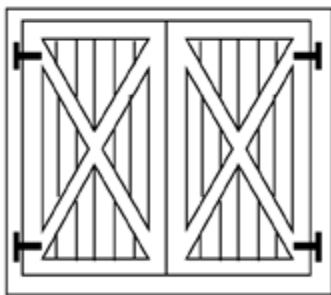
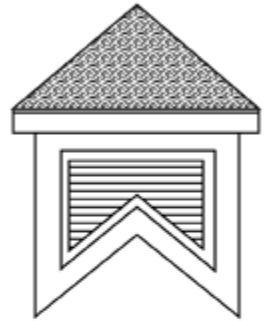
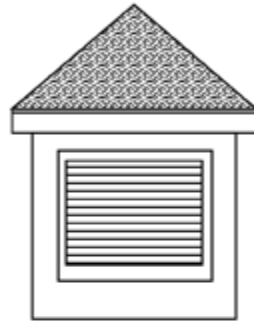
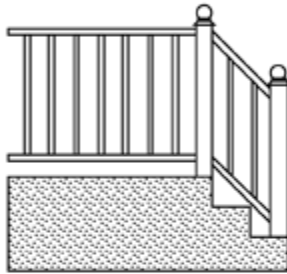
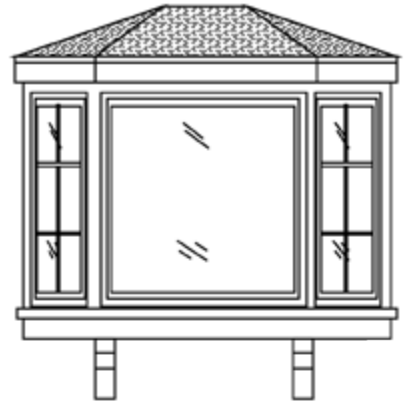
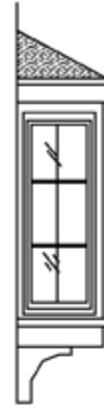

# Floor Plans:

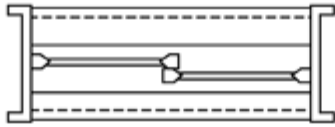
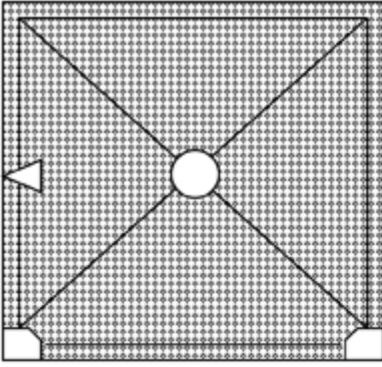

basement window

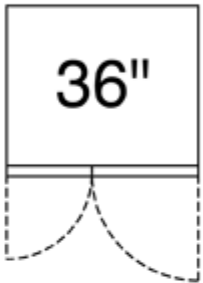
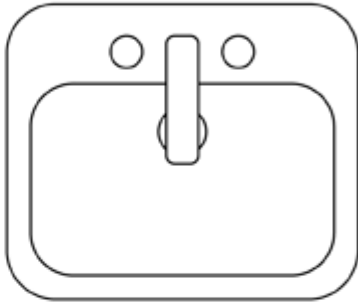
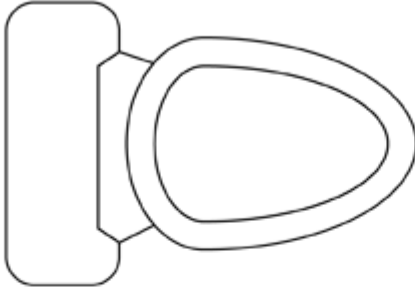
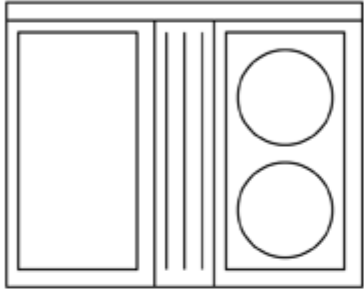
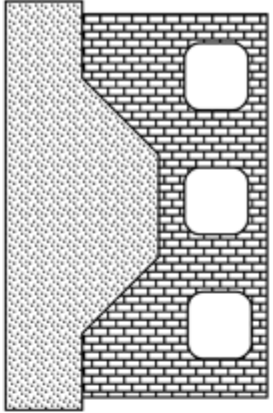
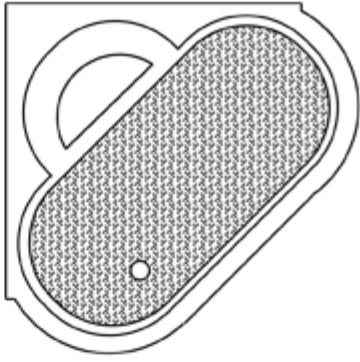

36"

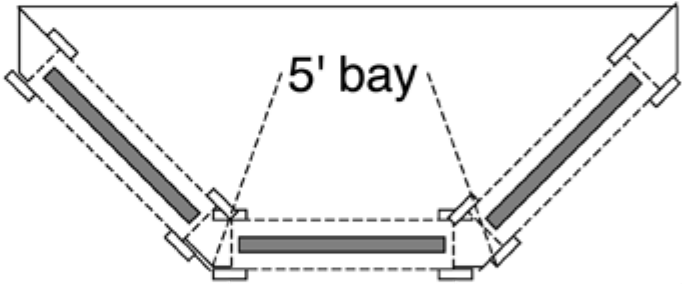
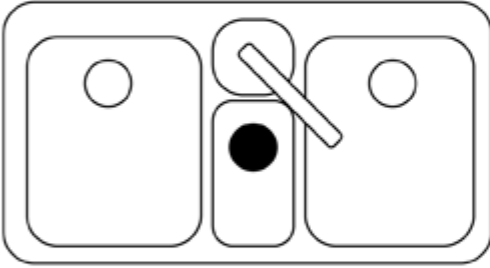

5' bay

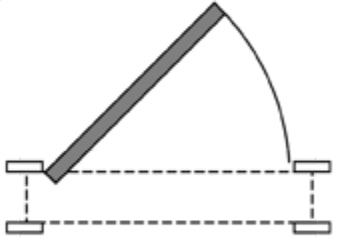

21x



9' picture window

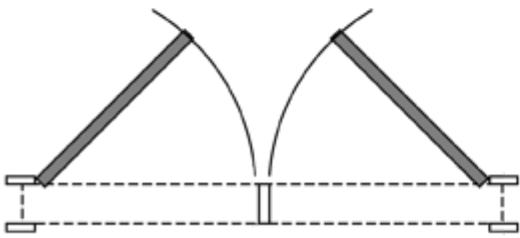

2-25x35c

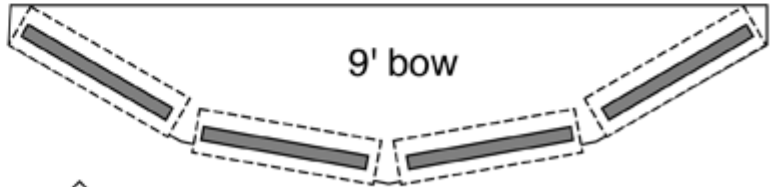

9' bow



5/0x6/8

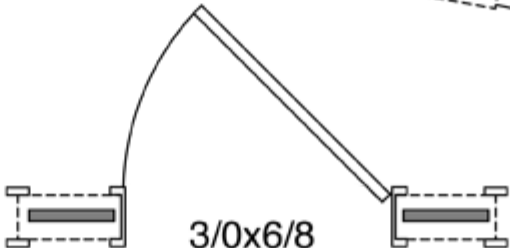

3/0x6/8  
12" sidelights



skylight

# Sectionals:

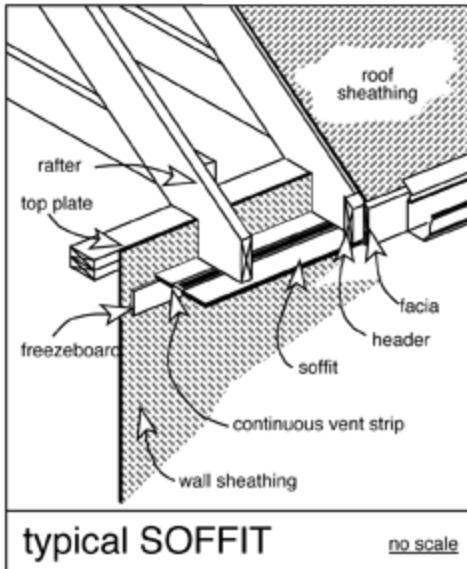
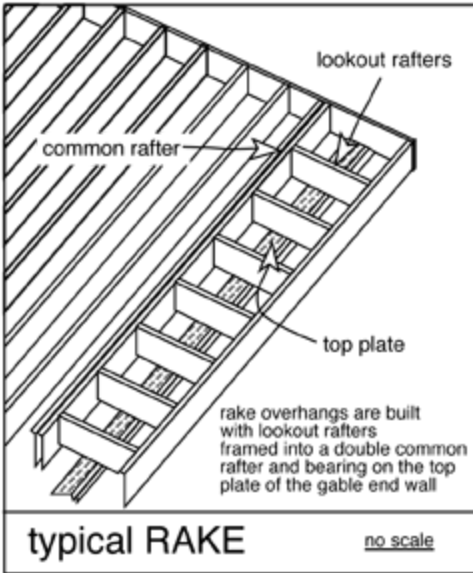

## fire separation wall no scale

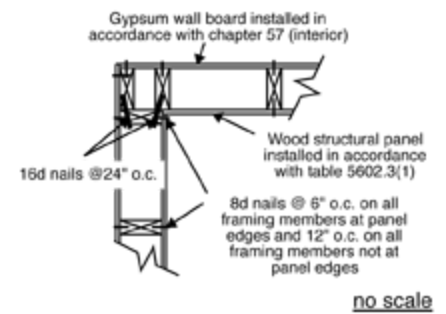
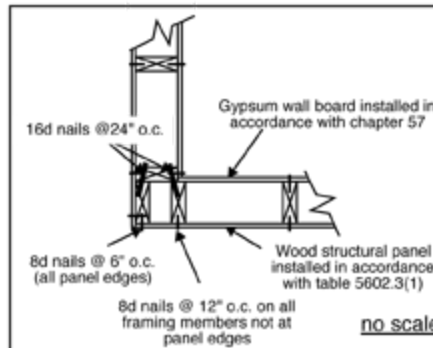
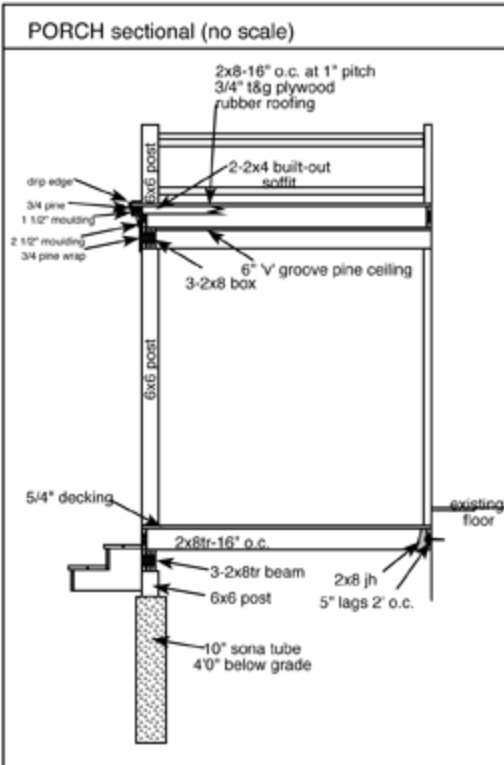
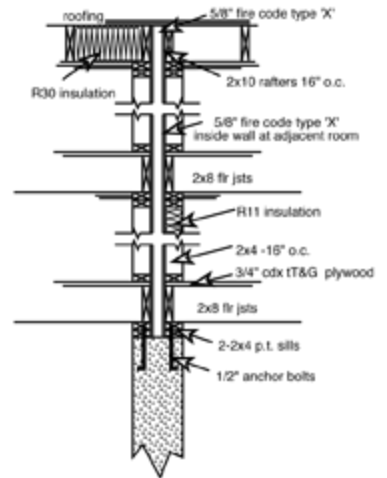

FIGURE 5602.10.5  
EXTERIOR CORNER FRAMING

